

# STRUCTURE - PLANCHER

## TRAVERSE

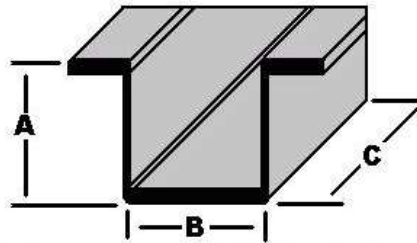

# PIECES	HAUTEUR	LARGEUR	LONGUEUR	MATÉRIAU	PLAQUES	FABRICANT
	A	B	C			
4001-B-103	2-1/8"	9"	101-3/16"	ACIER	NON	UTILITY
4001-B-232	3-1/8"	6"	100-5/8"	ACIER	OUI	TRAILMOBILE
4001-B-401	3-3/8"		101-2/3"	ACIER	OUI	MANAC
4001-B-500	2-1/4"	10"	101-3/8"	ACIER	OUI	FRUEHAUF
4001-B-604	3-3/4"	6-5/16"	101-9/32"	ALUMINIUM	NON	GREAT DANE
4001-B-607	2"	7-1/2"	100-15/32"	ACIER	NON	GREAT DANE
4001-B-608	2"	7-1/2"	101-1/8"	ACIER	NON	GREAT DANE
4001-B-610	2-1/4"	7"	101-3/8"	ACIER	NON	GREAT DANE
4001-B-611	4"	8-7/32"	101-3/8"	ACIER	NON	GREAT DANE
4001-B-621				ACIER	NON	VANGUARD
4001-B-623	3-3/4"	6-5/16"	100-31/32"	ALUMINIUM	NON	VANGUARD
4001-B-707	4"	5"	101-5/8"	ALUMINIUM	OUI	WABASH
4001-B-711		8"				HYUNDAI
4001-B-911	2"	7-3/4"	109-9/16"	ACIER	NON	STOUGHTON
4001-B-912	2"	7-3/4"	101-1/8"	ACIER	NON	STOUGHTON

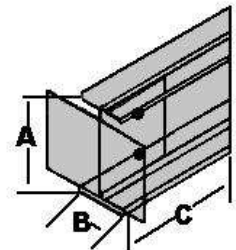
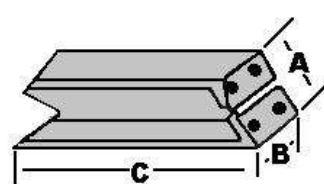
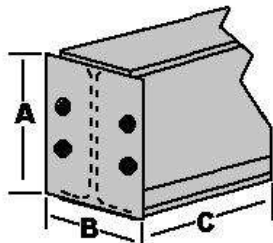
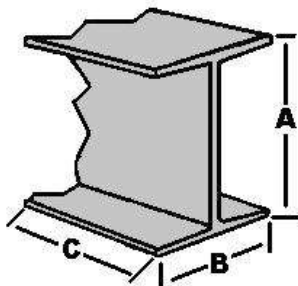

# PIECES	HAUTEUR	LARGEUR	LONGUEUR	MATÉRIAU	PLAQUES	FABRICANT
	A	B	C			
4001-3-34-5	6	2-1/4	102	ACIER	NON	UNIVERSEL
4001-A3-101B	4	2-1/4	101	ACIER	SOUDÉES	TRAILMOBILE
4001-B-115	4		101-3/4	ALUMINIUM	NON	UTILITY
4001-B-125	4	2-1/4	101-3/4	ALUMINIUM	BOULONNÉES	UTILITY
4001-B-126	5-1/2	2-1/4	101-3/4	ALUMINIUM	BOULONNÉES	UTILITY
4001-B-169	4		101-3/4	ACIER	SOUDÉES	UTILITY
4001-B-199	4		101-3/4	ACIER	SOUDÉES	UTILITY
4001-B-400	4	2-1/4		ACIER	SOUDÉES	MANAC
4001-B-502	4	2-1/4	101-3/8	ACIER	SOUDÉES	FRUEHAUF
4001-B-503	4	2-1/4	101-3/8	ACIER	REPLIÉES	FRUEHAUF
4001-B-504	4	3	101-1/2	ALUMINIUM	NON	TRAILMOBILE
4001-B-506	4	2-1/4	101-1/2	ACIER	NON	UNIVERSEL
4001-B-508	4	2-1/4	101-1/2	ACIER	NON	UNIVERSEL GOUDRONNÉ
4001-B-510	4	2-1/4	102	ACIER	NON	FRUEHAUF
4001-B-511	4	3 - 2-1/2	101-1/8	ALUMINIUM	NON	UNIVERSEL
4001-B-512	4	2-3/4 - 2-1/4	102	ALUMINIUM	NON	UNIVERSEL
4001-B-513	4-3/4	2-3/4 - 2	102	ALUMINIUM	NON	UNIVERSEL
4001-B-514	5	2-3/4	102	ALUMINIUM	NON	UNIVERSEL
4001-B-600	4	2-1/4	101-23/64	ACIER	NON	GREAT DANE
4001-B-601	4-1/8		101-2/3	ALUMINIUM	BOULONNÉES	GREAT DANE
4001-B-602	2-3/8	2-1/2 - 2-1/4	101-9/32	ACIER	NON	TRAILMOBILE
4001-B-603	3	1-7/8	101-1/2	ACIER	NON	UNIVERSEL

# STRUCTURE - PLANCHER

## TRAVERSE

# PIÈCES	HAUTEUR	LARGEUR	LONGUEUR	MATÉRIAU	PLAQUE	FABRICANT
	A	B	C			
4001-B-605	4			ALUMINIUM		GREAT DANE
4001-B-606	3		101-2/3	ACIER	SOUDÉES	GREAT DANE
4001-B-609	5		101-5/16	ALUMINIUM	BOULONNÉES	GREAT DANE
4001-B-620	4	2-1/4	101-1/2	ACIER	SOUDÉES	VANGUARD
4001-B-622	4	2-1/4	101-1/2	ACIER	REPLIÉES	VANGUARD
4001-B-624	4		100-3/5	ACIER	NON	VANGUARD
4001-B-625	4		100-3/5	ALUMINIUM	NON	VANGUARD
4001-B-626	5		100-3/5	ALUMINIUM	NON	VANGUARD
4001-B-700	4	2-1/4	101	ACIER	SOUDÉES	WABASH
4001-B-701	4		101-5/8	ACIER	SOUDÉES	WABASH
4001-B-702	4		101-5/8	ACIER	SOUDÉES	WABASH
4001-B-704	4	3	101-5/8	ALUMINIUM	SOUDÉES	WABASH
4001-B-705	5	3	101-5/8	ALUMINIUM	SOUDÉES	WABASH
4001-B-706	4	2-1/4	100-3/8	ACIER	SOUDÉES	WABASH
4001-B-710	4		101-1/2	ACIER	SOUDÉES	HYUNDAI
4001-B-712	4			ACIER	SOUDÉES	HYUNDAI

## PLAQUES

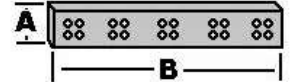
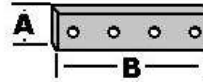
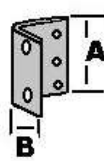
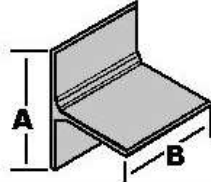
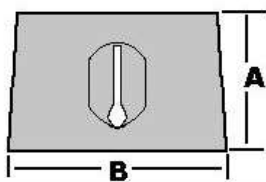

# PIÈCES	TYPE	HAUTEUR	LARGEUR	LONGUEUR	MATÉRIAU	PERCÉ	EMPLOI	FABRICANT
		A	B	C				
4001-0-100	ANGLE	3-9/16	1-9/16 - 1-9/16		ALUMINIUM	OUI	4" ALUM.	UTILITY
4001-0-101	PLAQUE	3-3/4	3-1/4	10 GA	ACIER	OUI	4" ACIER	UTILITY
4001-0-501	Plaque fendue	3-3/4	5-3/4	12 GA	ACIER	NON	4" ACIER	UNIVERSEL
4001-0-502	PLAQUE	3	4-3/16	10 GA	ACIER	OUI	4" ACIER	FRUEHAUF
4001-0-505	T	3-5/8	3-1/8	3-1/32	ALUMINIUM	NON	4" ALUM.	FRUEHAUF
4001-0-506	T	5-1/2	3-1/8	3-1/2	ALUMINIUM	NON	4" ALUM.	UNIVERSEL
4001-0-507	T	5-1/2	4-7/8	3-1/2	ALUMINIUM	NON	5" ALUM.	UNIVERSEL
4001-0-508	Plaque fendue	3-9/16	3-1/8	10 GA	ACIER	OUI	4" ACIER	UNIVERSEL
4001-0-509	Plaque fendue	4	5	10 GA	ACIER	OUI	4" ACIER	UNIVERSEL
4001-0-519	Plaque fendue	3-5/8	3-1/8	10 GA	ACIER	NON	4" ACIER	UNIVERSEL
4001-0-520	PLAQUE	5	4		ACIER	NON	4" ACIER	UNIVERSEL
4001-0-521	PLAQUE	4	4		ACIER	NON	4" ACIER	UNIVERSEL
4001-0-600	T	3-29/32			ALUMINIUM	NON		GREAT DANE
4001-0-601	T	5	4	3-1/2	ACIER	NON		GREAT DANE
4001-0-602	T	5-1/2	3-1/4	2-1/2	ALUMINIUM	NON		GREAT DANE
4001-0-603	T	5-1/2	4-1/4	2-1/2	ALUMINIUM	NON		GREAT DANE
4001-0-604	T	5-1/2	4-1/4	2-1/2	ALUMINIUM	NON		GREAT DANE
4001-0-605	PLAQUE	3-1/2	3-1/2		ACIER	NON		GREAT DANE
4001-0-620	T	3-25/32	3-13/64	2-1/2	ACIER	OUI	4" ACIER	VANGUARD
4001-0-621L	T	3-25/32	4-13/64	2-1/2	ALUMINIUM	OUI	5" alum.gau.	VANGUARD
4001-0-621R	T	3-25/32	4-13/64	2-1/2	ALUMINIUM	OUI	5" alum.droit	VANGUARD
4001-0-622	PLAQUE	4	57-29/32		ALUMINIUM	OUI	AVANT	VANGUARD
4001-0-700	T	3-1/2	3-1/4	2-1/2	ALUMINIUM	NON		WABASH
4001-0-701	PLAQUE	4-15/16	4-15/16		ACIER	OUI		WABASH
4001-0-702	PLAQUE	3-15/16	4-15/16		ACIER	OUI		WABASH
4001-0-710	PLAQUE	4	5-13/64		ACIER	NON		HYUNDAI
4001-0-902	ANGLE	3-1/18	2 - 1-5/8	10 GA	ACIER	OUI	4" ALUM.	TRAILMOBILE
4001-0-903	ANGLE	3-3/8	2 - 1-5/8	10 GA	ACIER	OUI	4-1/4" ALUM.	TRAILMOBILE
4001-0-904	PLAQUE	4-1/4	3-3/8	10 GA	ALUMINIUM	OUI	4-1/4" ACIER	TRAILMOBILE
4001-0-910	T	3-1/4			ACIER	OUI	ALUM.	STOUGHTON
4001-0-911	PLAQUE	1-3/4	7-1/2		ACIER	OUI	AVANT	STOUGHTON
4001-0-912	PLAQUE	4	3-1/8		ACIER	OUI	4" ACIER	STOUGHTON

# STRUCTURE - PLANCHER

## BOULON DE TRAVERSE

### TROUSSE DE BOULONS

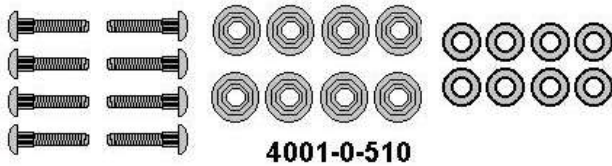

4001-0-510

### BOULON EMPREINTE TORX

4001-0-515	3/8"-16 X 1-1/4"
4001-0-517	3/8"-16 X 1"
4001-0-517 SS	3/8"-16 X 1" inox
4001-0-518 NF	3/8"-24 X 1"

### ÉCROU

4001-0-516 NF	3/8"-24
423-6-112	3/8"-16
RONDELLE NYLON	
4001-0-511	3/8" (D-I)

### BOIS DE CHÊNE

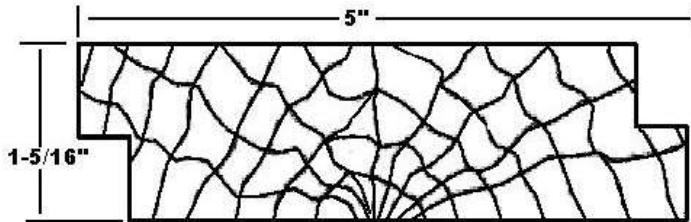

434-1-005

### PLANCHE D'ÉRABLE LAMINÉE

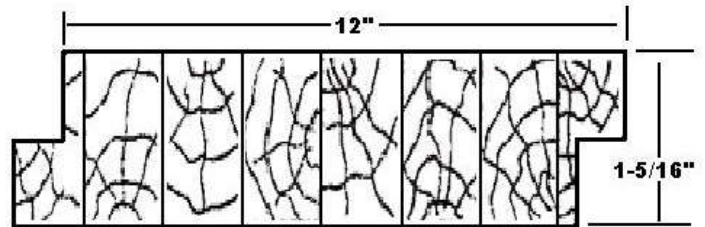

434-1-012

## CONDUITS ÉLECTRIQUES

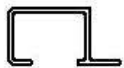

ACIER  
ou  
ALUMINIUM

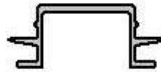

ALUMINIUM

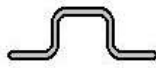

ACIER



ALUMINIUM

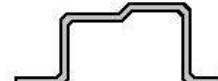

ACIER



PVC

## TYPES PLANCHERS ALUMINIUM

SUR COMMANDE SEULEMENT FOURNIR NOM DU MANUFACTURIER ET NUMÉRO DE SÉRIE DE L'UNITÉ

### CONSTRUCTION

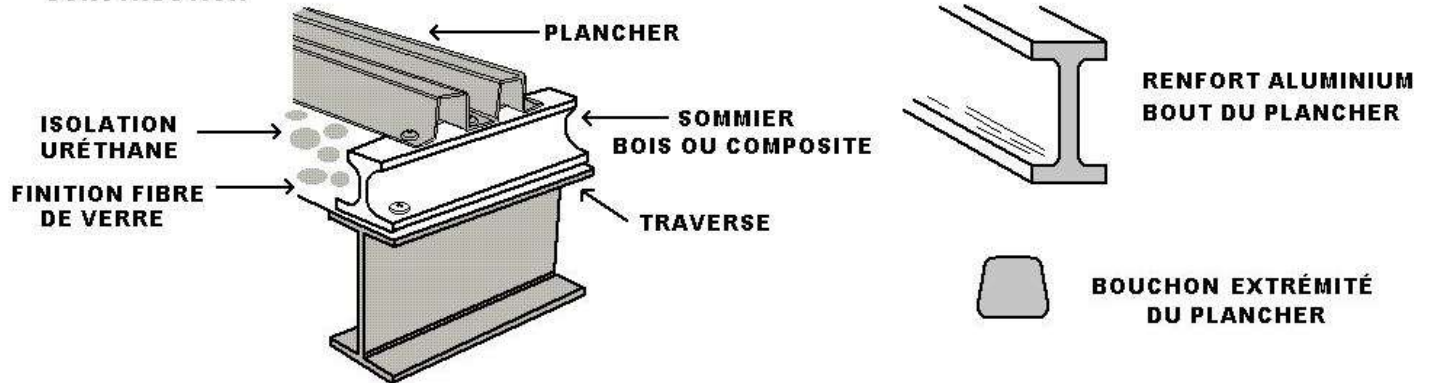

À CANIVEAU, FOURGON RÉFRIGÉRÉ, RÉGULIER OU ANTIDÉRAPANT

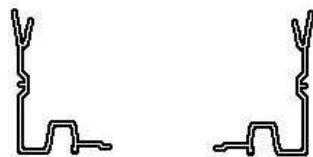

GAUCHE

DROITE

EXTRÉMITÉS LATÉRALES, PLANCHER À CANIVEAU, FOURGON RÉFRIGÉRÉ



PLAT, FOURGON RÉFRIGÉRÉ, RÉGULIER OU ANTIDÉRAPANT



PLAT, FOURGON SEC, NON-ISOLÉ, OPTION AU PLANCHER DE BOIS RÉGULIER

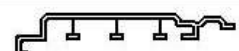

PLAT, PLATEFORME, OPTION AU PLANCHER DE BOIS RÉGULIER